

Silicon – Diode Array

FSA2509P

16 Diode Array

60V/350mA

DATASHEET

OEM – Fairchild

Source: Fairchild Databook 1978

FSA2509M • FSA2509P • FSA2510M • FSA2510P

PLANAR AIR-ISOLATED MONOLITHIC DIODE ARRAYS*

- C... 5.0 pF (MAX)
- ΔV_F ... 15 mV (MAX) @ 10 mA

ABSOLUTE MAXIMUM RATINGS (Note 1)

Temperatures

Storage Temperature Range (M Suffix)
(P Suffix)
Maximum Junction Operating Temperature
Lead Temperature

-55°C to +200°C
-55°C to +150°C
+150°C
+260°C

Power Dissipation (Note 2)

Maximum Dissipation per Junction at 25°C Ambient
Maximum Dissipation per Package at 25°C Ambient
Linear Derating factor (from 25°C) Junction
Package

400 mW
650 mW
3.2 mW / °C
5.2 mW / °C

Maximum Voltage and Currents

WIV Working Inverse Voltage
 I_F Continuous Forward Current
 $I_{F(surge)}$ Peak Forward Surge Current
Pulse Width = 1.0 s
Pulse Width = 1.0 μ s

40 V
350 mA
1.0 A
2.0 A

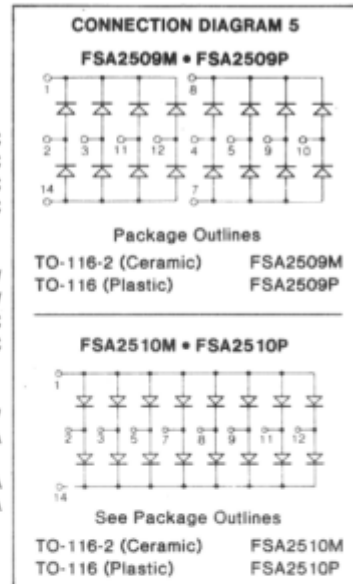

ELECTRICAL CHARACTERISTICS (25°C Ambient Temperature unless otherwise noted)

SYMBOL	CHARACTERISTIC	MIN	MAX	UNITS	TEST CONDITIONS
BV	Breakdown Voltage	60		V	$I_R = 10 \mu A$
V_F	Forward Voltage (Note 3)		1.0	V	$I_F = 100 \text{ mA}$
			1.1	V	$I_F = 200 \text{ mA}$
			1.3	V	$I_F = 500 \text{ mA}$
ΔV_F	Forward Voltage Match (Note 6)		15	mV	$I_F = 10 \text{ mA}$
I_R	Reverse Current (Note 4)		100	nA	$V_R = 40 \text{ V}$
			200	μA	$V_R = 40 \text{ V}, T_A = 150^\circ C$
C	Capacitance (Note 5)		5.0	pF	$V_R = 0, f = 1.0 \text{ MHz}$
t_{fr}	Forward Recovery Time (Note 6)		40	ns	$I_F = 500 \text{ mA}$
t_{rr}	Reverse Recovery Time (Note 6)		10	ns	$I_F = I_r = 10 \text{ mA to } 200 \text{ mA}$ $R_L = 100 \Omega, I_{rr} = 0.1 I_R$
			50	ns	$I_F = 500 \text{ mA}, I_r = 50 \text{ mA}$ $R_L = 100 \Omega, I_{rr} = 5.0 \text{ mA}$

NOTES:

1. These ratings are limiting values above which life or satisfactory performance may be impaired.
2. These are steady state limits. The factory should be consulted on applications involving pulsed or low duty-cycle operation.
3. V_F is measured using an 8 ms pulse.
4. See test circuits (Note 6) for measurement of reverse current of an individual diode.
5. The capacitance is measured from pin-to-pin across any one of the diodes. The interaction of other diodes is therefore included in the measured value.
6. For product family characteristic curves and test circuits, refer to Chapter 4, D15.

*DUAL 8-DIODE AND 16-DIODE CORE DRIVER MATRICES

FAIRCHILD • DIODE ARRAYS

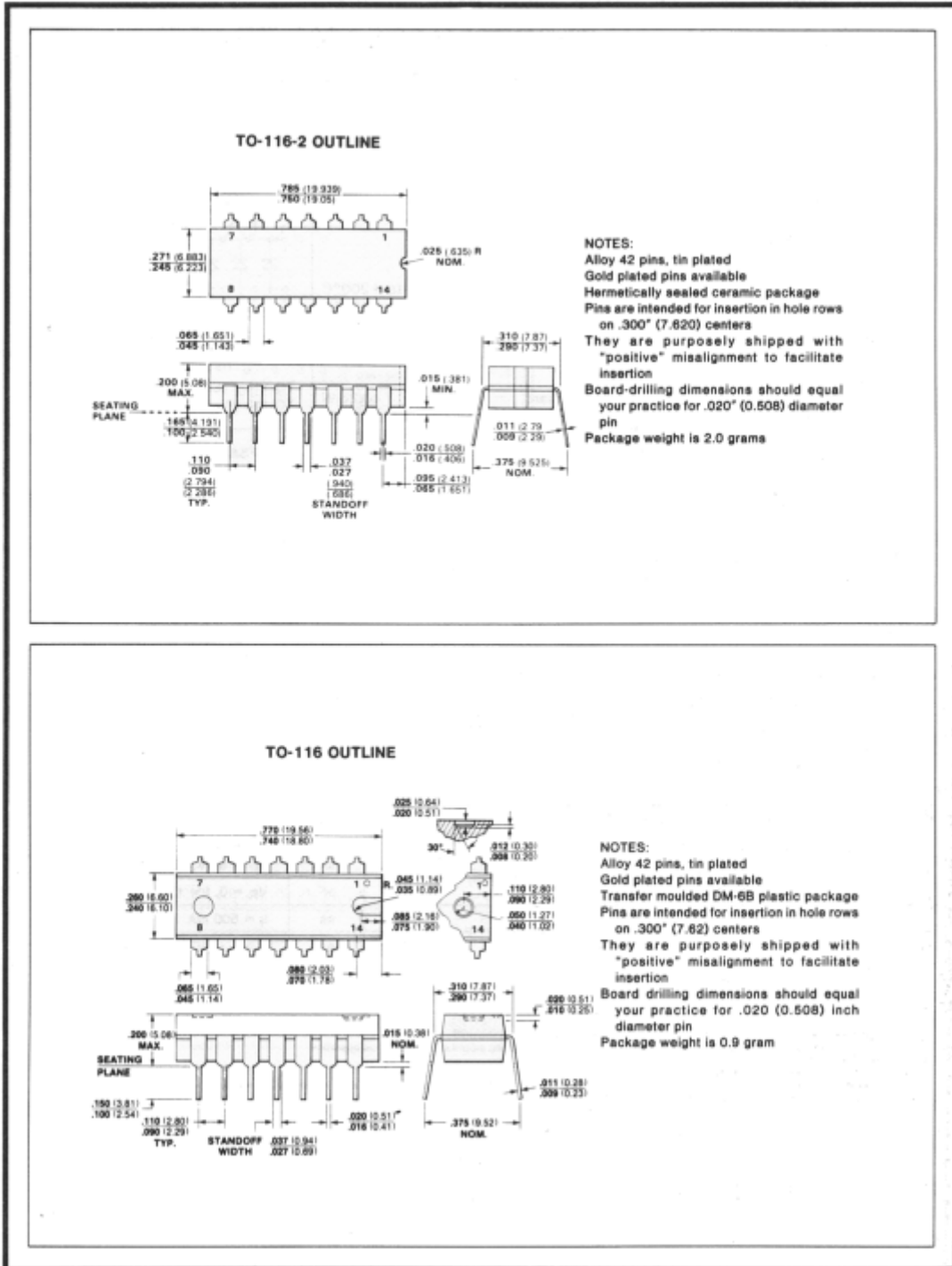

CURVE SET NUMBER D15
AIR-ISOLATED MONOLITHIC DIODE ARRAY

TYPICAL ELECTRICAL CHARACTERISTIC CURVES
 AT 25°C AMBIENT TEMPERATURE UNLESS OTHERWISE NOTED

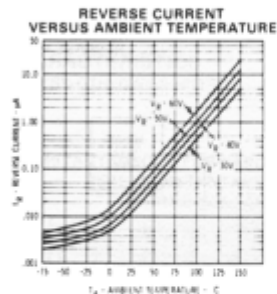
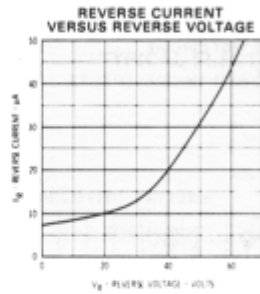
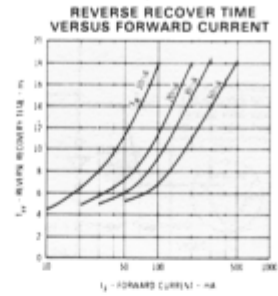
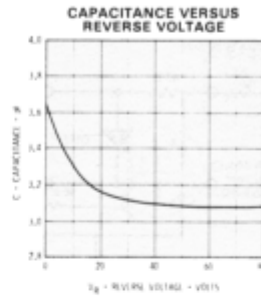
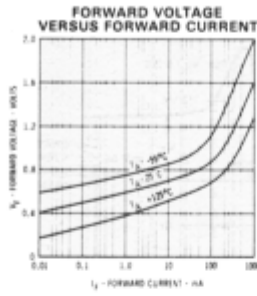

TEST CIRCUITS

To measure reverse current of an individual diode, the following test circuits are used:

COMMON CATHODE DIODES

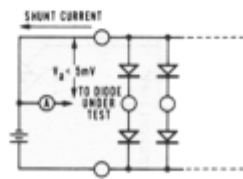

COMMON ANODE DIODES

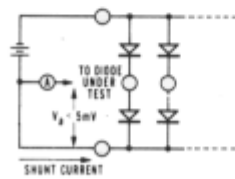

CURVE SET NUMBER D15
AIR-ISOLATED MONOLITHIC DIODE ARRAY

TEST CIRCUITS

Test requirement for V_{FM} and t_{rr} is as shown below; all leads should be as short as possible.

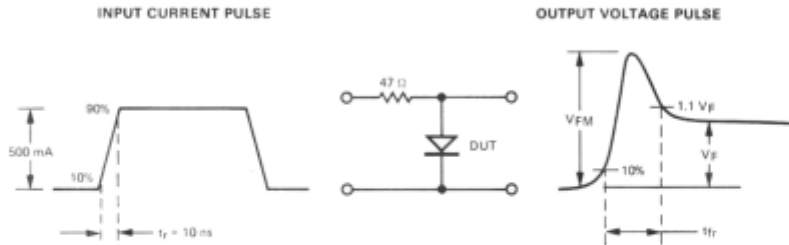

t_{rr} - REVERSE RECOVERY TIME TEST CIRCUIT
 $I_F = I_R = I_{rr} = 0.1 I_F$

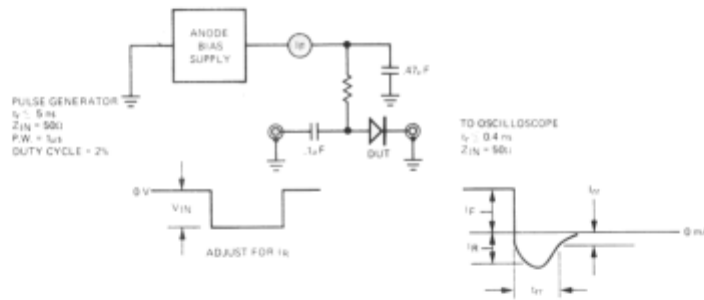

ΔV_F BRIDGE MATCHING CIRCUIT

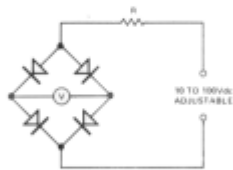

NOTES:

1. R Varies depending on the current range. For the most often used current ranges, R is as follows:

Current Range (amperes)	R (ohms)
10^{-5} to 10^{-4}	10^6
10^{-4} to 10^{-3}	10^5
10^{-3} to 10^{-2}	10^4
or 10^{-n} to 10^{-n+1}	10^{n+1}

2. V indicates mismatch of assembly.

ΔI_R BRIDGE MATCHING CIRCUIT

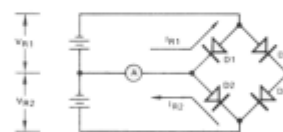

NOTES:

- $V_{R2} = V_{R1} \pm 1\%$.
- $I_{R2} - I_{R1} = \Delta I_R$ (difference in I_R between diodes D1 & D2). To measure diodes D3 & D4, reverse cathode-anode terminal connections.
- A is a center reading pico ammeter. ΔI_R indicated directly on A.