

Silicon Dual Diode

BYQ30ED-200

200V/16A

DATASHEET

OEM – Philips

Source: Philips Databook 1999

**Rectifier diodes
ultrafast, rugged**
BYQ30E, BYQ30EB, BYQ30ED series
FEATURES

- Low forward volt drop
- Fast switching
- Soft recovery characteristic
- Reverse surge capability
- High thermal cycling performance
- Low thermal resistance

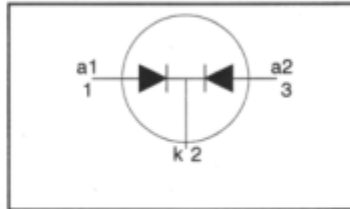
SYMBOL

QUICK REFERENCE DATA

$$V_R = 150 \text{ V} / 200 \text{ V}$$

$$V_F \leq 0.95 \text{ V}$$

$$I_{O(AV)} = 16 \text{ A}$$

$$I_{RRM} = 0.2 \text{ A}$$

$$t_{rr} \leq 25 \text{ ns}$$

GENERAL DESCRIPTION

Dual, ultra-fast, epitaxial rectifier diodes intended for use as output rectifiers in high frequency switched mode power supplies.

The BYQ30E series is supplied in the SOT78 conventional leaded package.

The BYQ30EB series is supplied in the SOT404 surface mounting package.

The BYQ30ED series is supplied in the SOT428 surface mounting package.

PINNING

PIN	DESCRIPTION
1	anode 1
2	cathode ¹
3	anode 2
tab	cathode

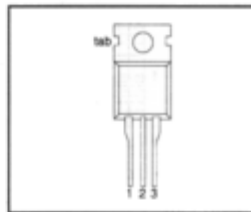
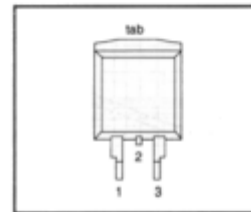
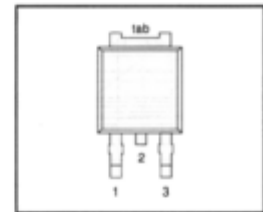
SOT78 (TO220AB)

SOT404

SOT428

LIMITING VALUES

Limiting values in accordance with the Absolute Maximum System (IEC 134)

SYMBOL	PARAMETER	CONDITIONS	MIN.	MAX.		UNIT
V_{RRM}	Peak repetitive reverse voltage	BYQ30E/ BYQ30EB/ BYQ30ED	-	-150	-200	V
V_{RWM}	Working peak reverse voltage		-	150	200	V
V_R	Continuous reverse voltage		-	150	200	V
$I_{O(AV)}$	Average rectified output current (both diodes conducting)	square wave; $\delta = 0.5$; $T_{mb} \leq 104 \text{ }^\circ\text{C}$	-	16		A
I_{FRM}	Repetitive peak forward current per diode	square wave; $\delta = 0.5$; $T_{mb} \leq 104 \text{ }^\circ\text{C}$	-	16		A
I_{FSM}	Non-repetitive peak forward current per diode	$t = 10 \text{ ms}$	-	80		A
		$t = 8.3 \text{ ms}$	-	88		A
I_{RRM}	Peak repetitive reverse surge current per diode	sinusoidal; with reapplied $V_{RRM(max)}$ $t_p = 2 \text{ } \mu\text{s}$; $\delta = 0.001$	-	0.2		A
I_{RSM}	Peak non-repetitive reverse surge current per diode	$t_p = 100 \text{ } \mu\text{s}$	-	0.2		A
T_j	Operating junction temperature		-	150		$^\circ\text{C}$
T_{stg}	Storage temperature		-40	150		$^\circ\text{C}$

1. It is not possible to make connection to pin 2 of the SOT428 or SOT404 packages.

Rectifier diodes
ultrafast, rugged

BYQ30E, BYQ30EB, BYQ30ED series

ESD LIMITING VALUE

SYMBOL	PARAMETER	CONDITIONS	MIN.	MAX.	UNIT
V_C	Electrostatic discharge capacitor voltage	Human body model; $C = 250 \text{ pF}$; $R = 1.5 \text{ k}\Omega$	-	8	kV

THERMAL RESISTANCES

SYMBOL	PARAMETER	CONDITIONS	MIN.	TYP.	MAX.	UNIT
$R_{th,jmb}$	Thermal resistance junction to mounting base	per diode both diodes	-	-	3	K/W
$R_{th,ja}$	Thermal resistance junction to ambient	SOT78 package, in free air SOT404 and SOT428 packages, pcb mounted, minimum footprint, FR4 board	-	60 50	-	K/W K/W

ELECTRICAL CHARACTERISTICS

All characteristics are per diode at $T_j = 25 \text{ }^\circ\text{C}$ unless otherwise specified

SYMBOL	PARAMETER	CONDITIONS	MIN.	TYP.	MAX.	UNIT
V_F	Forward voltage	$I_F = 8 \text{ A}$; $T_j = 150 \text{ }^\circ\text{C}$ $I_F = 16 \text{ A}$; $T_j = 150 \text{ }^\circ\text{C}$ $I_F = 16 \text{ A}$	-	0.84 1 1.12	0.95 1.15 1.25	V V V
I_R	Reverse current	$V_R = V_{RWM}$ $V_R = V_{RWM}$; $T_j = 100 \text{ }^\circ\text{C}$	-	4 0.3	30 0.6	μA mA
Q_{rr}	Reverse recovered charge	$I_F = 2 \text{ A}$; $V_R \geq 30 \text{ V}$; $-di_F/dt = 20 \text{ A}/\mu\text{s}$	-	4	11	nC
t_{rr1}	Reverse recovery time	$I_F = 1 \text{ A}$; $V_R \geq 30 \text{ V}$; $-di_F/dt = 100 \text{ A}/\mu\text{s}$	-	20	25	ns
t_{rr2}	Reverse recovery time	$I_F = 0.5 \text{ A}$ to $I_R = 1 \text{ A}$; $I_{rec} = 0.25 \text{ A}$	-	12	22	ns
V_{fr}	Forward recovery voltage	$I_F = 1 \text{ A}$; $di_F/dt = 10 \text{ A}/\mu\text{s}$	-	1	-	V

Rectifier diodes
ultrafast, rugged

BYQ30E, BYQ30EB, BYQ30ED series

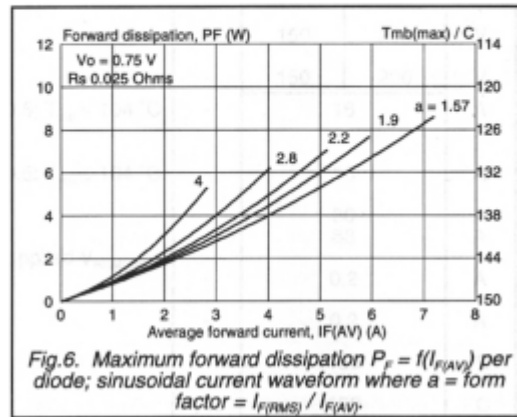
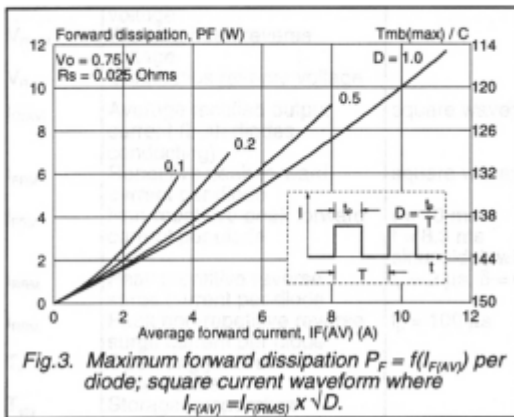
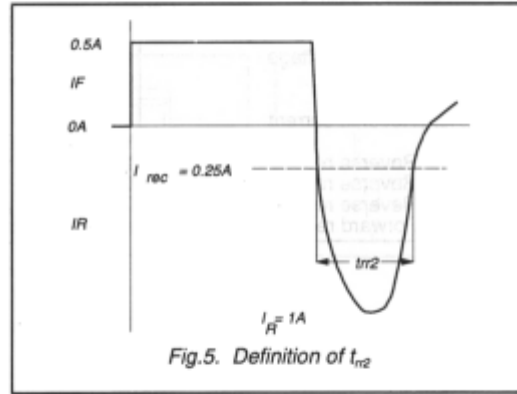
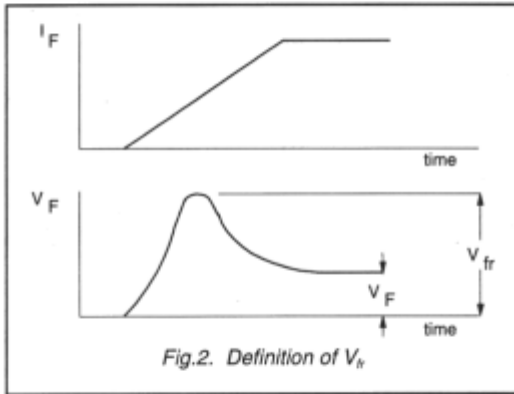
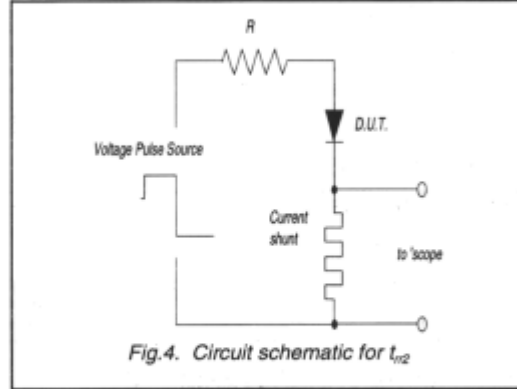
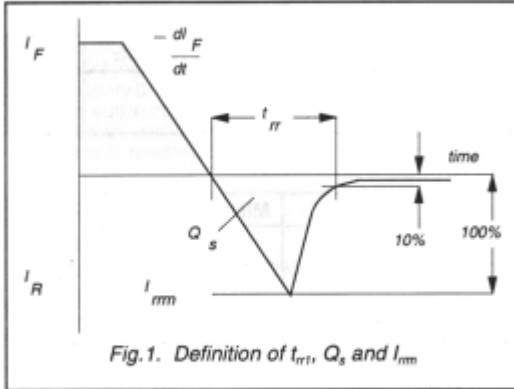

Rectifier diodes
ultrafast, rugged

BYQ30E, BYQ30EB, BYQ30ED series

