

N-Channel MOSFET Transistor

2SK134 / K134

140V / 7A

DATASHEET

OEM – Hitachi

Source: Hitachi Databook Power Mosfet Data 4/83

2SK133,2SK134,2SK135

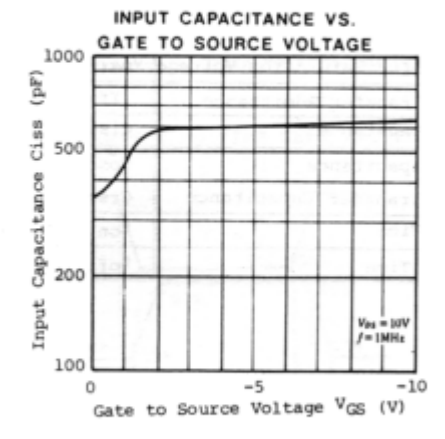
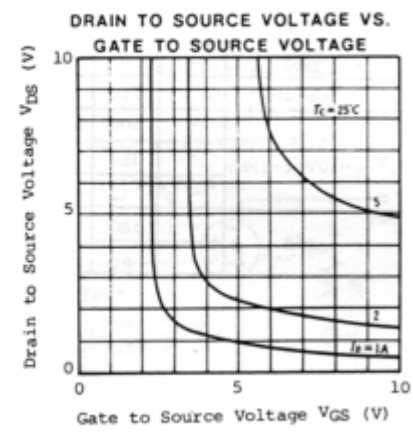
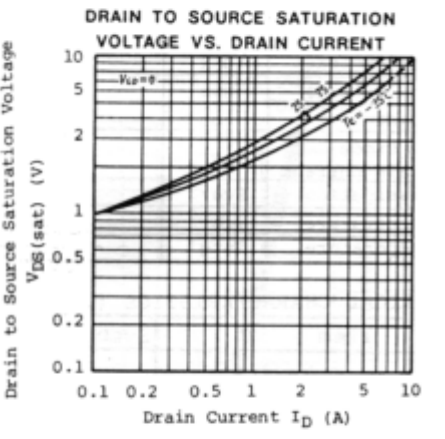
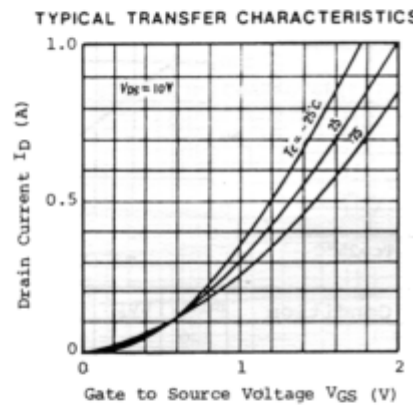
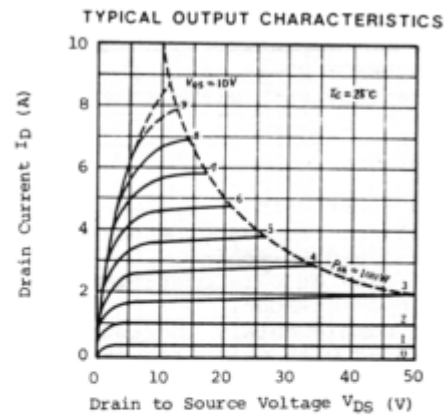
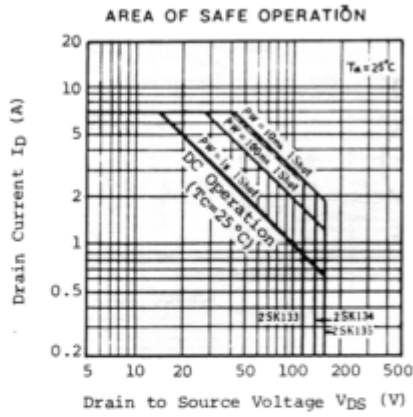

2SK133,2SK134,2SK135

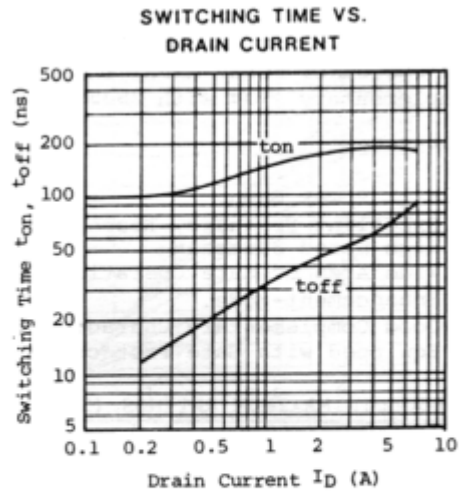
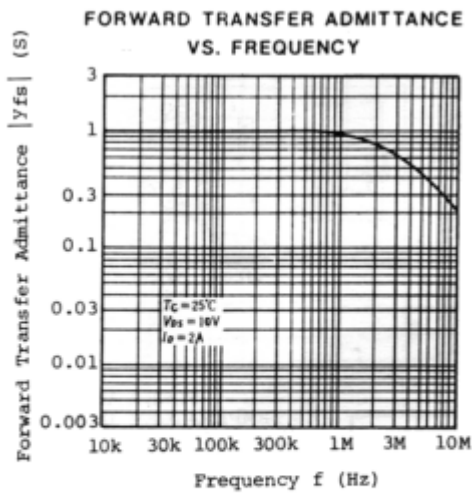

SWITCHING TIME TEST CIRCUIT

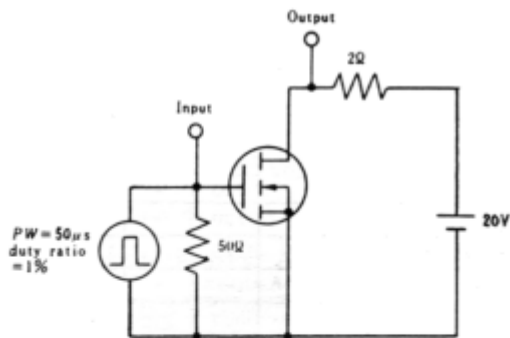

RESPONSE WAVEFORM

