

Silicon Dual Diode

BYQ28EX-200

200V/10A

DATASHEET

OEM – Philips

Source: Philips Databook 1999

Rectifier diodes ultrafast, rugged

BYQ28F, BYQ28EX series

FEATURES

- Low forward volt drop
- Fast switching
- Soft recovery characteristic
- Reverse surge capability
- High thermal cycling performance
- Isolated mounting tab

SYMBOL

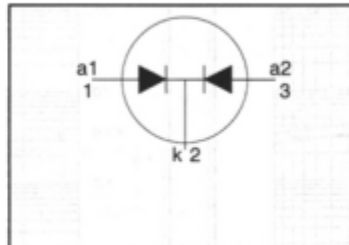

QUICK REFERENCE DATA

$$V_R = 150 \text{ V} / 200 \text{ V}$$

$$V_F \leq 0.895 \text{ V}$$

$$I_{O(AV)} = 10 \text{ A}$$

$$I_{RRM} = 0.2 \text{ A}$$

$$t_{tr} \leq 25 \text{ ns}$$

GENERAL DESCRIPTION

Dual, ultra-fast, epitaxial rectifier diodes intended for use as output rectifiers in high frequency switched mode power supplies.

The BYQ28F series is supplied in the SOT186 package.
The BYQ28EX series is supplied in the SOT186A package.

PINNING

PIN	DESCRIPTION
1	anode 1 (a)
2	cathode (k)
3	anode 2 (a)
tab	isolated

SOT186

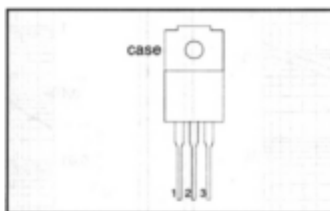

SOT186A

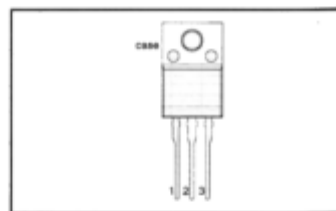

LIMITING VALUES

Limiting values in accordance with the Absolute Maximum System (IEC 134).

SYMBOL	PARAMETER	CONDITIONS	MIN.	MAX.		UNIT
				BYQ28F / BYQ28EX		
V_{RRM}	Peak repetitive reverse voltage	$T_{hs} \leq 148^\circ\text{C}$	-	-150	-200	V
V_{RWM}	Crest working reverse voltage		-	150	200	V
V_R	Continuous reverse voltage		-	150	200	V
$I_{O(AV)}$	Average rectified output current (both diodes conducting) ¹	square wave $\delta = 0.5$; $T_{hs} \leq 92^\circ\text{C}$	-	10		A
I_{FRM}	Repetitive peak forward current per diode	$t = 25 \mu\text{s}$; $\delta = 0.5$; $T_{hs} \leq 92^\circ\text{C}$	-	10		A
I_{FSM}	Non-repetitive peak forward current per diode	$t = 10 \text{ ms}$	-	50		A
		$t = 8.3 \text{ ms}$ sinusoidal; with reapplied	-	55		A
I_{RRM}	Repetitive peak reverse current per diode	$V_{RWM(max)}$ $t_p = 2 \mu\text{s}$; $\delta = 0.001$	-	0.2		A
I_{RSM}	Non-repetitive peak reverse current per diode	$t_p = 100 \mu\text{s}$	-	0.2		A
T_{sig}	Storage temperature		-40	150		$^\circ\text{C}$
T_j	Operating junction temperature		-	150		$^\circ\text{C}$

¹ Neglecting switching and reverse current losses

Rectifier diodes
ultrafast, rugged

BYQ28F, BYQ28EX series

ESD LIMITING VALUE

SYMBOL	PARAMETER	CONDITIONS	MIN.	MAX.	UNIT
V_C	Electrostatic discharge capacitor voltage	Human body model; $C = 250 \text{ pF}$; $R = 1.5 \text{ k}\Omega$	-	8	kV

ISOLATION LIMITING VALUE & CHARACTERISTIC

$T_{ns} = 25 \text{ }^\circ\text{C}$ unless otherwise specified

SYMBOL	PARAMETER	CONDITIONS	MIN.	TYP.	MAX.	UNIT
V_{isol}	Peak isolation voltage from all terminals to external heatsink	SOT186 package; R.H. $\leq 65\%$; clean and dustfree	-	-	1500	V
V_{isol}	R.M.S. isolation voltage from all terminals to external heatsink	SOT186A package; $f = 50\text{-}60 \text{ Hz}$; sinusoidal waveform; R.H. $\leq 65\%$; clean and dustfree	-	-	2500	V
C_{isol}	Capacitance from pin 2 to external heatsink	$f = 1 \text{ MHz}$	-	10	-	pF

THERMAL RESISTANCES

SYMBOL	PARAMETER	CONDITIONS	MIN.	TYP.	MAX.	UNIT
R_{thj-hs}	Thermal resistance junction to heatsink	with heatsink compound	-	-	5.7	K/W
R_{thj-a}	Thermal resistance junction to ambient	without heatsink compound in free air	-	55	6.7	K/W

ELECTRICAL CHARACTERISTICS

characteristics are per diode at $T_j = 25 \text{ }^\circ\text{C}$ unless otherwise stated

SYMBOL	PARAMETER	CONDITIONS	MIN.	TYP.	MAX.	UNIT
V_F	Forward voltage	$I_F = 5 \text{ A}$; $T_j = 150 \text{ }^\circ\text{C}$	-	0.80	0.895	V
		$I_F = 5 \text{ A}$	-	0.95	1.10	V
		$I_F = 10 \text{ A}$	-	1.10	1.25	V
I_R	Reverse current	$V_R = V_{RWM}$; $T_j = 100 \text{ }^\circ\text{C}$	-	0.1	0.2	mA
		$V_R = V_{RWM}$	-	2	10	μA
Q_s	Reverse recovery charge	$I_F = 2 \text{ A}$; $V_R \geq 30 \text{ V}$; $-di_F/dt = 20 \text{ A}/\mu\text{s}$	-	4	9	nC
t_{rr1}	Reverse recovery time	$I_F = 1 \text{ A}$; $V_R \geq 30 \text{ V}$; $-di_F/dt = 100 \text{ A}/\mu\text{s}$	-	15	25	ns
t_{rr2}	Reverse recovery time	$I_F = 0.5 \text{ A}$ to $I_R = 1 \text{ A}$; $I_{rec} = 0.25 \text{ A}$	-	10	20	ns
I_{rrm}	Peak reverse recovery current	$I_F = 5 \text{ A}$; $V_R \geq 30 \text{ V}$; $-di_F/dt = 50 \text{ A}/\mu\text{s}$	-	0.5	0.7	A
V_{fr}	Forward recovery voltage	$I_F = 1 \text{ A}$; $di_F/dt = 10 \text{ A}/\mu\text{s}$	-	1	-	V

Rectifier diodes
ultrafast, rugged

BYQ28F, BYQ28EX series

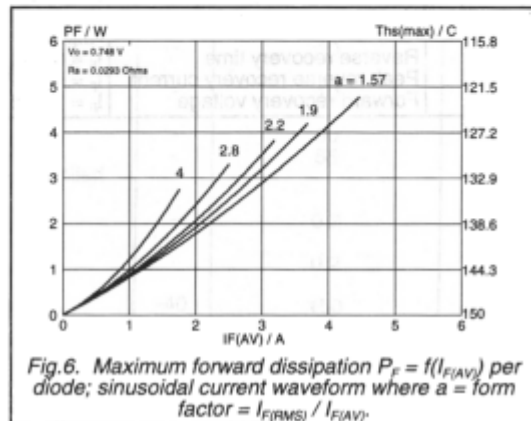
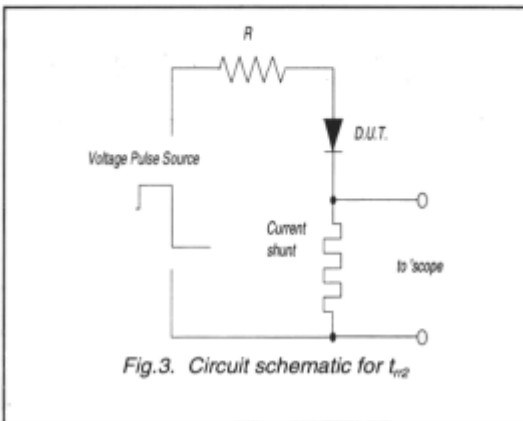
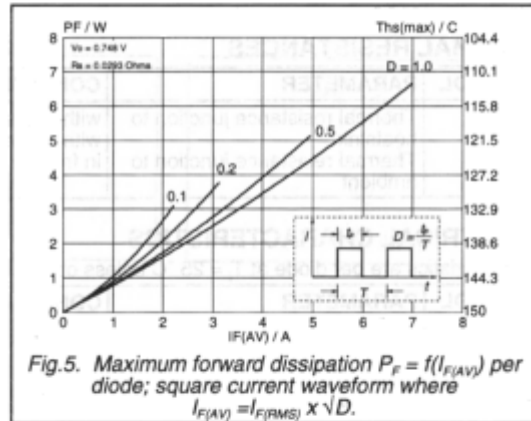
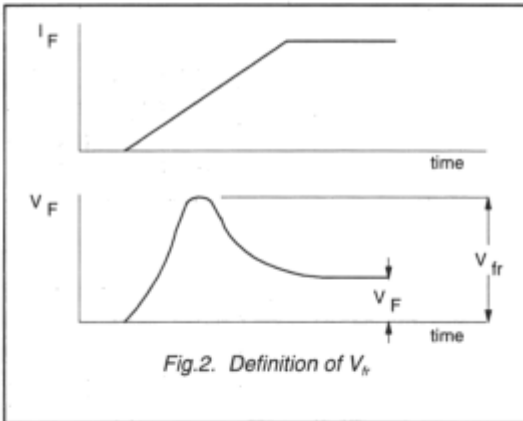
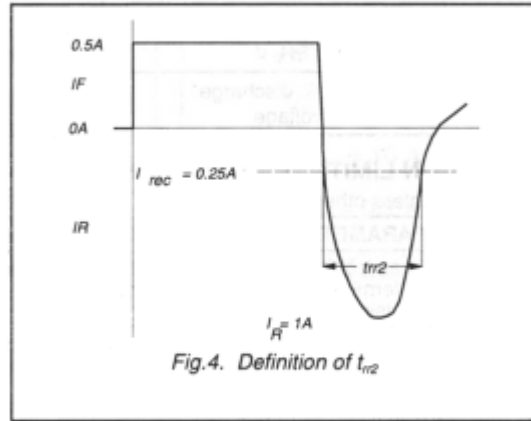
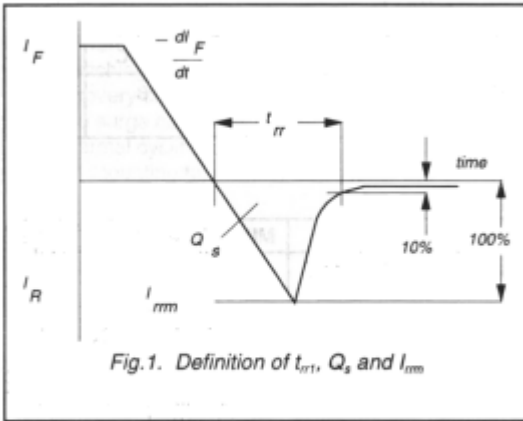

Rectifier diodes
ultrafast, rugged

BYQ28F, BYQ28EX series

