

Integrated Circuit

TBA810S

Audio power amplifier

DATASHEET

OEM – Telefunken

Source: Telefunken Databook 1979/80

TBA 810 S · TBA 810 AS

Monolithisch Integrierte Schaltung Monolithic Integrated Circuit

Anwendung: NF-Leistungsverstärker

Application: Audio power amplifier

Besondere Merkmale:

- Thermische Abschaltung
- Hoher Ausgangsstrom bis 2,5 A
- Großer Versorgungsspannungsbereich, 4 bis 20 V
- Hohe Ausgangsleistung, 7 W
- Kleine Übernahmeverzerrungen
- Kleiner Klirrfaktor
- Sehr guter Wirkungsgrad, 70%

Features:

- Thermal shut-down
- High output current, up to 2.5 A
- Wide range of supply voltage, 4 to 20 V
- High output power 7 W
- Low cross-over distortion
- Low harmonic distortion
- Very high efficiency 70%

**Abmessungen in mm
Dimensions in mm**

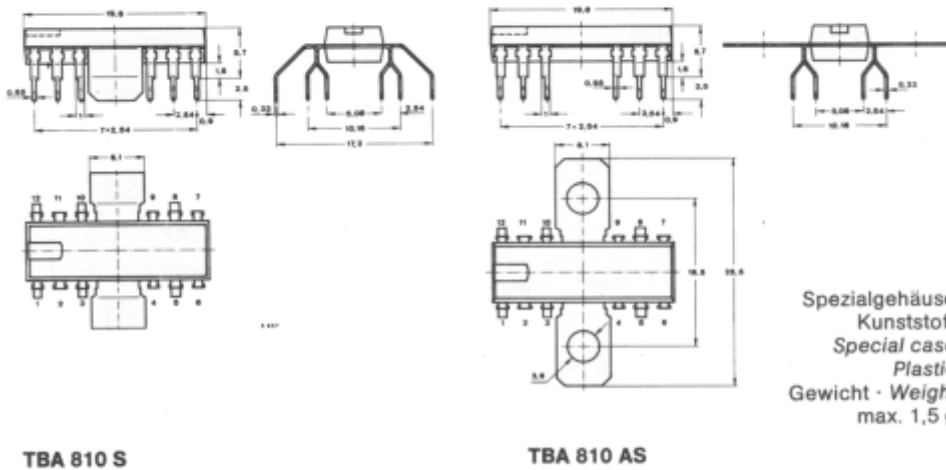

TBA 810 S · TBA 810 AS

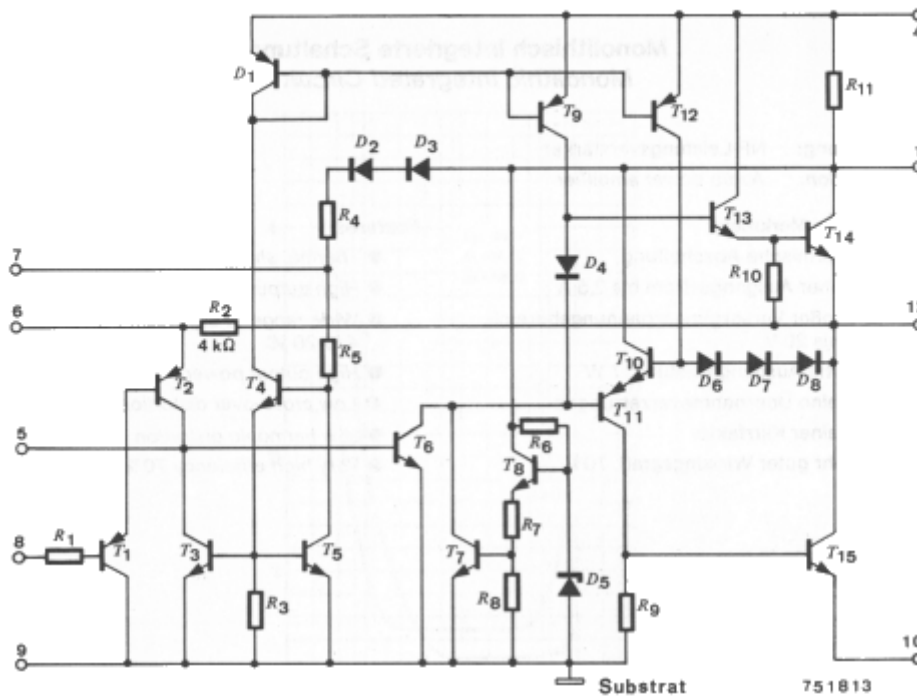
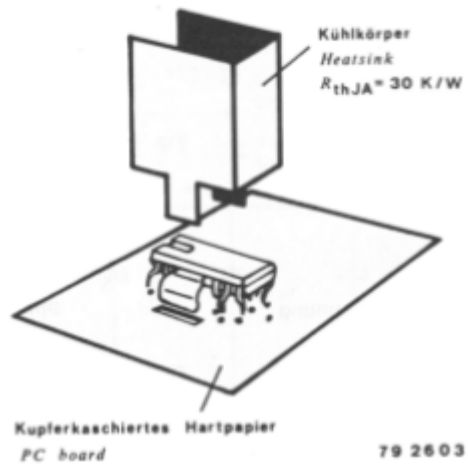
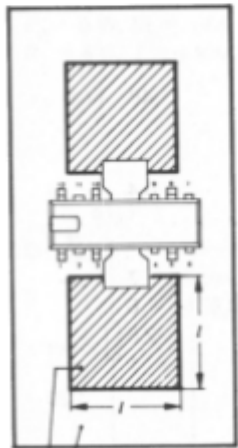
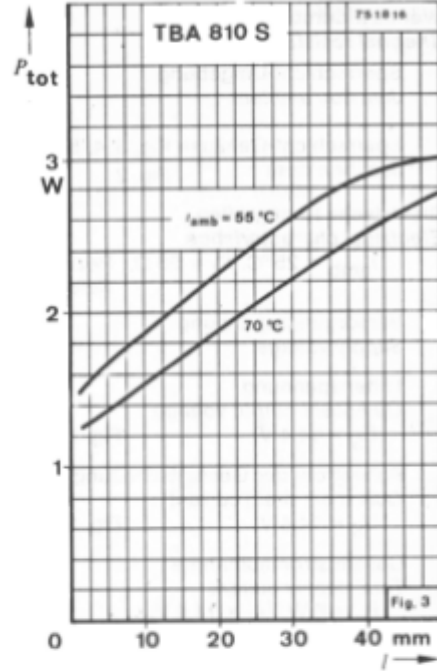
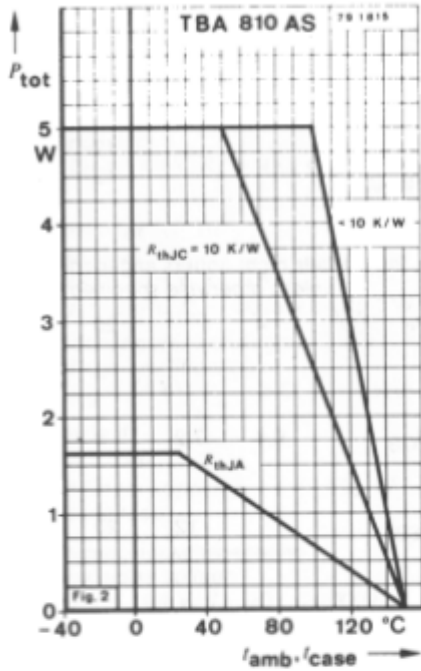

Fig. 1 Schaltung und Anschlußbelegung
Diagram and pin connections

Absolute Grenzdaten Absolute maximum ratings

Bezugspunkt Reference point		Pin 9, Pin 10			
Versorgungsspannung Supply voltage	Pin 1	U_S	20	V	
Ausgangsstoßstrom Surge output current	Pin 12	I_{QS}	3,5	A	
Ausgangsspitzenstrom Peak output current (repetitive)	Pin 12	I_{QM}	2,5	A	
Verlustleistung Power dissipation	Fig. 2, 3, 4, 5, 6				
$t_{amb} = 80^\circ\text{C}$	TBA 810 S	P_{tot}	1	W	
$t_{case} = 100^\circ\text{C}$	TBA 810 AS	P_{tot}	5	W	
Sperrschichttemperatur Junction temperature		t_j	+150	$^\circ\text{C}$	
Lagerungstemperaturbereich Storage temperature range		t_{stg}	-40 ... +150	$^\circ\text{C}$	

TBA 810 S · TBA 810 AS



TBA 810 S · TBA 810 AS

Wärmewiderstände Thermal resistances

			Min.	Typ.	Max.	
Sperrschicht-Umgebung Junction ambient	TBA 810 S TBA 810 AS	R_{thJA} R_{thJA}			70 80	K/W K/W
Sperrschicht-Gehäuse Junction case	Fig. 3, 4, 5 Fig. 2	TBA 810 S TBA 810 AS	$R_{thJC}^{1)}$ $R_{thJC}^{1)}$		12 10	K/W K/W

Elektrische Kenngrößen Electrical characteristics

		Bezugspunkt: Reference point:	Pin 9, Pin 10	falls nicht anders angegeben unless otherwise specified			
$t_{amb} = 25^\circ\text{C}$, $R_f = 56 \Omega$							
Versorgungsspannung Supply voltage		Pin 1	U_S	4	20		V
Mittenspannung Quiescent output voltage $U_S = 14,4 \text{ V}$	Fig. 13	Pin 12	U_{QB}	6,4	7,2	8	V
Ruhestrom der Gesamtschaltung Quiescent drain current $U_S = 14,4 \text{ V}$	Fig. 12	Pin 1	I_{SB}		12	20	mA
Gesamtstromaufnahme Total supply current $P_q = 6 \text{ W}$, $U_S = 14,4 \text{ V}$, $R_L = 4 \Omega$		Pin 1	$I_{S tot}$		600		mA
Thermische Abschalttemperatur Thermal shut-down temperature $P_{tot} = 2,8 \text{ W}$	Fig. 11		t_{case}		120		$^\circ\text{C}$
Brummunterdrückung Supply voltage rejection ratio $U_S = 14,4 \text{ V}$, $R_L = 4 \Omega$, $f_{Br} = 100 \text{ Hz}$	Fig. 14, 15		k_{SVR}		48		dB
Eingangsstrom Input current $U_S = 14,4 \text{ V}$		Pin 8	I_{IB}		0,4	4	μA
Ausgangsleistung Output power $R_L = 4 \Omega$, $f = 1 \text{ kHz}$, $k = 10\%$	Fig. 6, 8, 9, 10, 11						
			$U_S = 16,0 \text{ V}$		7		W
			$U_S = 14,4 \text{ V}$	4,6	6		W
			$U_S = 9,0 \text{ V}$		2,5		W
			$U_S = 6,0 \text{ V}$		1		W
Eingangsspannung Input voltage		Pin 8	U_i			220	mV
Eingangsspannung Input voltage $U_S = 14,4 \text{ V}$, $P_q = 6 \text{ W}$, $f = 1 \text{ kHz}$, $R_L = 4 \Omega$	Fig. 18	Pin 8					
		$R_f = 56 \Omega$	U_i		80		mV
		$R_f = 22 \Omega$	U_i		35		mV

¹⁾ mit Kühlfläche $R_{thCA} = 10^\circ\text{C/W}$
with cooling plate

TBA 810 S · TBA 810 AS

			Min.	Typ.	Max.	
Eingangswiderstand Input resistance	Pin 8	R_i		5		M Ω
Bandbreite (-3 dB) Band width	Fig. 16					
$U_S = 14,4 \text{ V}$, $R_L = 4 \Omega$, $C_3 = 820 \text{ pF}$		B		40 ... 20000		Hz
$C_3 = 1500 \text{ pF}$		B		40 ... 10000		Hz
Klirrfaktor Distortion	Fig. 6, 19, 20					
$U_S = 14,4 \text{ V}$, $R_L = 4 \Omega$, $f = 1 \text{ kHz}$, $P_q = 50 \text{ mW}$ bis/to 3 W		k		0,3		%
Spannungsverstärkungen Voltage amplifications						
$U_S = 14,4 \text{ V}$, $R_L = 4 \Omega$, $f = 1 \text{ kHz}$						
Leerlauf Open loop		A_{ug}		80		dB
mit Gegenkopplung closed loop	Fig. 17	A_{uf}	34	37	40	dB
Eingangsrauschspannung Input noise voltage						
$U_S = 14,4 \text{ V}$, $B = 20 \dots 20000 \text{ Hz}$	Pin 8	U_{ni}		2		μV
Eingangsrauschstrom Input noise current						
$U_S = 14,4 \text{ V}$, $B = 20 \dots 20000 \text{ Hz}$	Pin 8	I_{ni}		0,1		nA
Wirkungsgrad Efficiency	Fig. 6, 9					
$P_q = 5 \text{ W}$, $U_S = 14,4 \text{ V}$, $R_L = 4 \Omega$, $f = 1 \text{ kHz}$		η		70		%

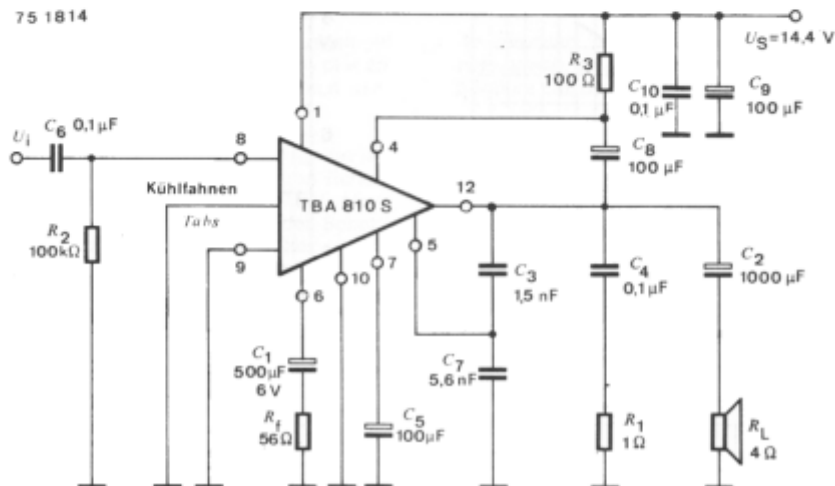
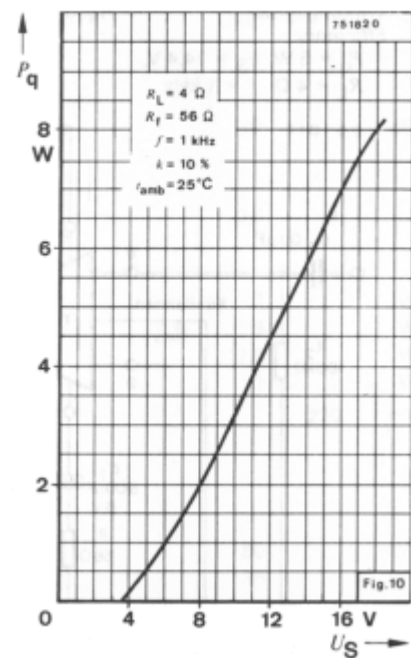
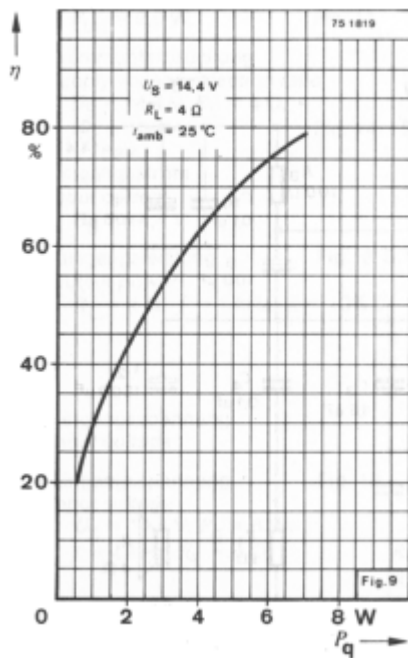
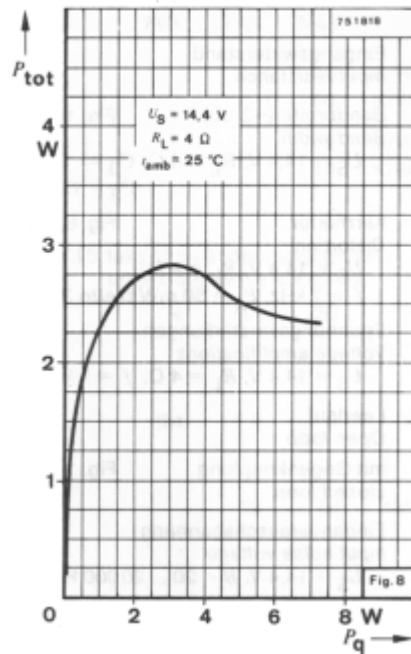
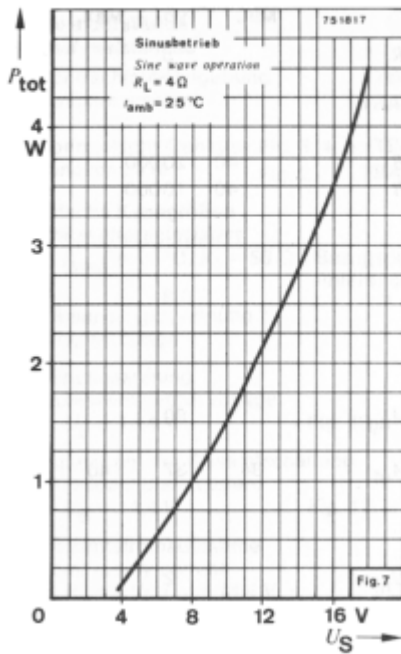
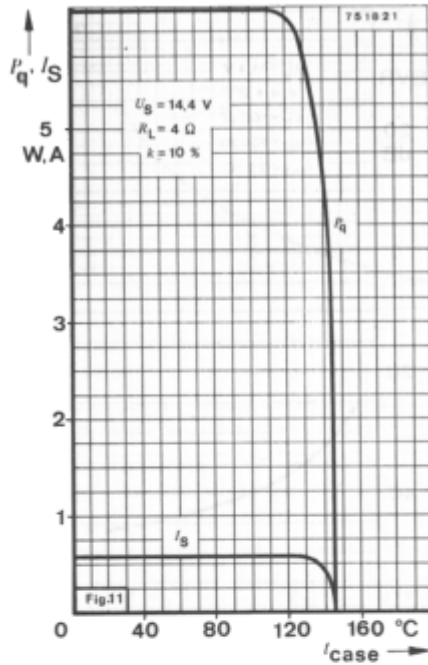

Fig. 6 Meßschaltung für: P_q , P_{tot} , k , η und Anwendungsbeispiel
Test circuit for: and application note

TBA 810 S · TBA 810 AS



TBA 810 S · TBA 810 AS



Thermisches Abschalten:

Die eingebaute thermische Begrenzerschaltung ergibt folgende Vorteile:

1. Eine dauernde Überlastung des Ausgangs oder eine Erhöhung der zulässigen oberen Umgebungstemperatur kann einfach verhindert werden.
2. Die Kühlung kann gegenüber konventionellen Schaltungen mit einem kleineren Sicherheitsfaktor ausgelegt werden. Bei einer thermischen Überlastung wird der Schaltkreis nicht infolge einer zu hohen Sperrschichttemperatur zerstört, denn es wird ausschließlich P_Q (und somit P_{tot}) und I_S reduziert (siehe Fig. 11).

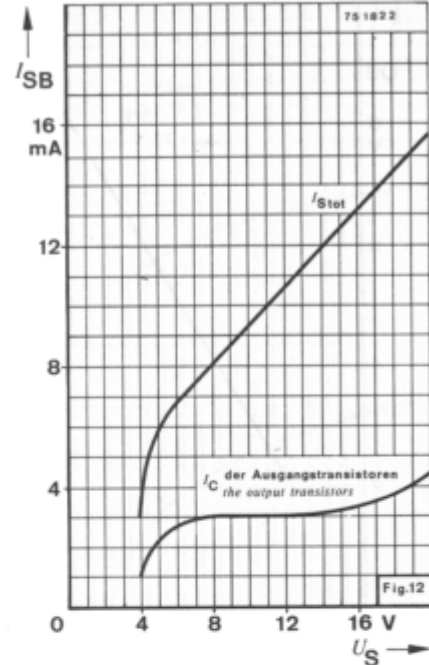

Thermal shut-down

The presence of a thermal limiting circuit offers the following advantages:

1. An overload on the output (even if it is permanent), or an above-limit ambient temperature can be easily supported.
2. The heat sink can have a smaller factor of safety compared with that of a conventional circuit. There is no device damage in the case of too high a junction temperature: all that happens is that P_Q (and therefore P_{tot}) and I_S are reduced (fig. 11).

TBA 810 S · TBA 810 AS

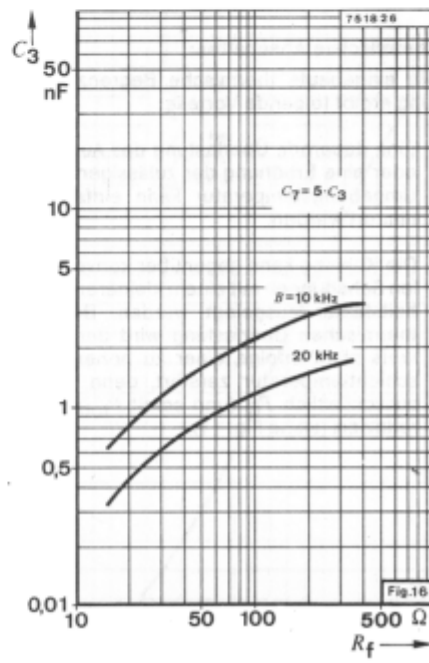
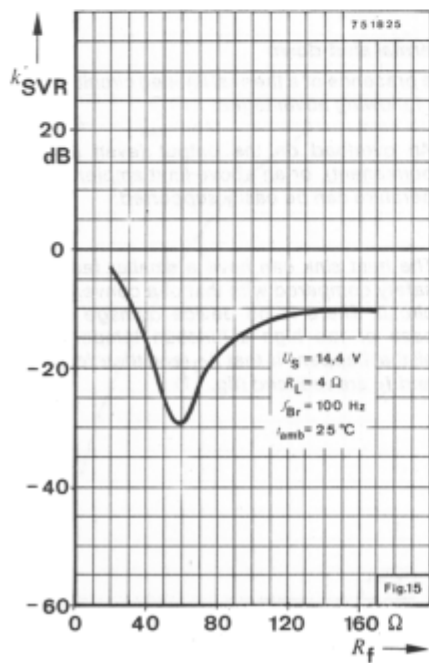
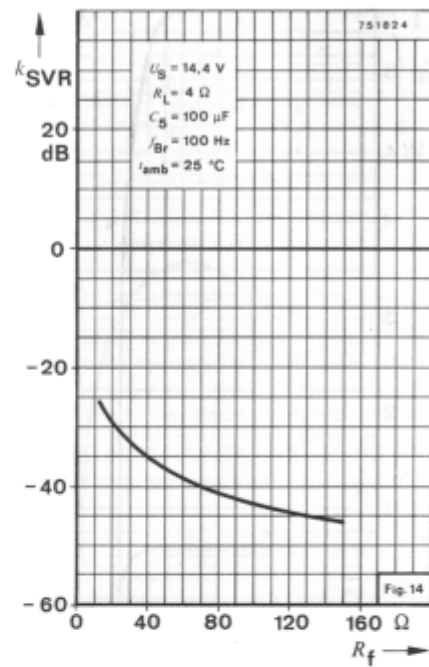
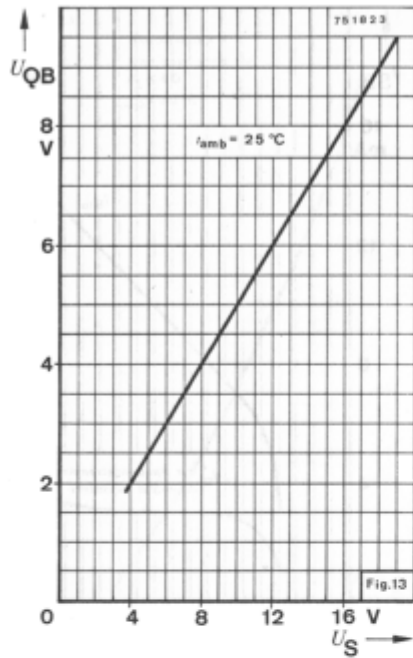

TBA 810 S · TBA 810 AS

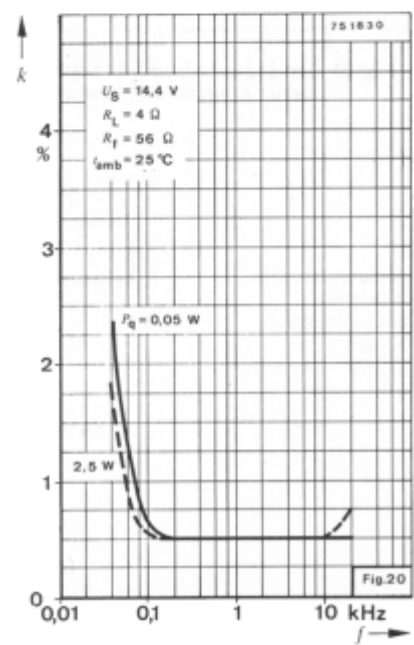
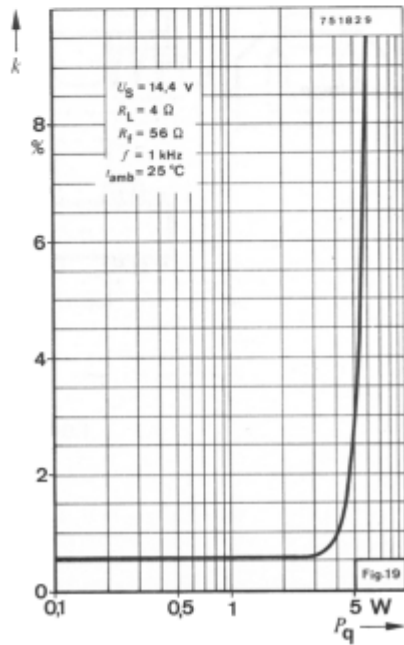
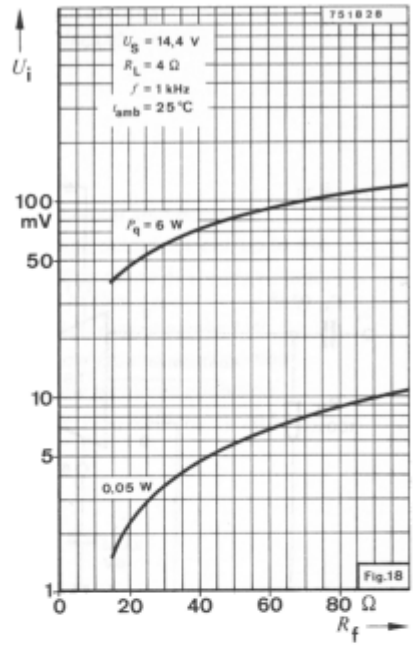
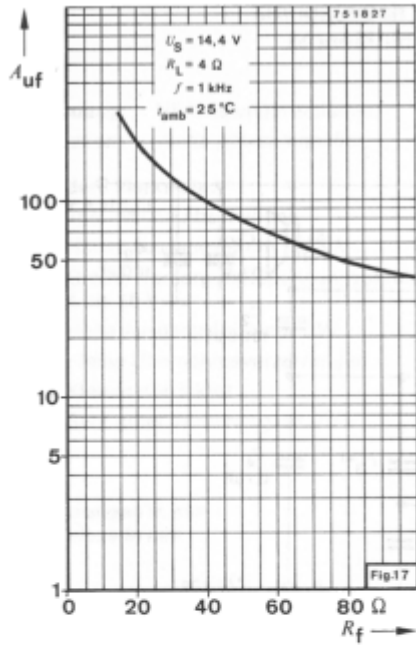

TBA 810 S · TBA 810 AS

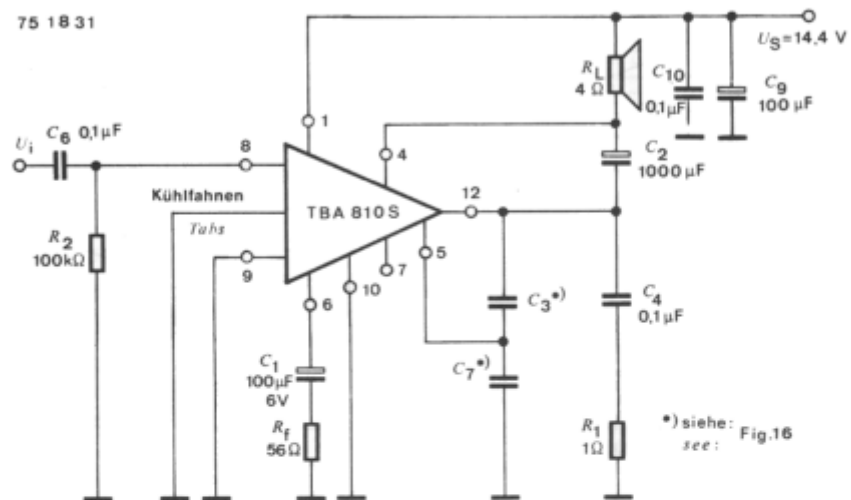

Fig. 21 Schaltungsbeispiel mit hochliegendem R_L
 Circuit example with load connected to supply voltage